

# Çocuk Dünyasında Kabe

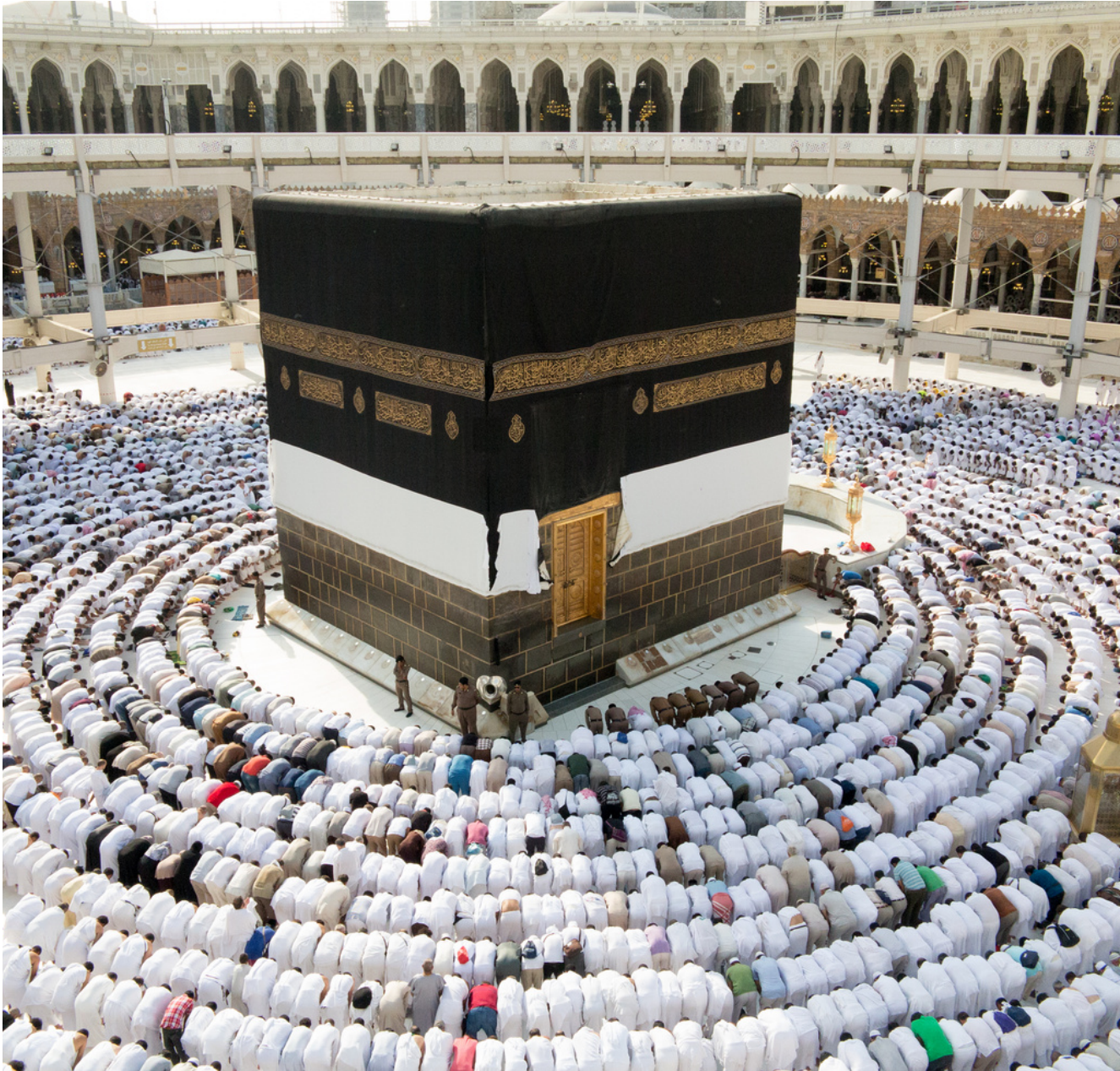

@degerogretmeni

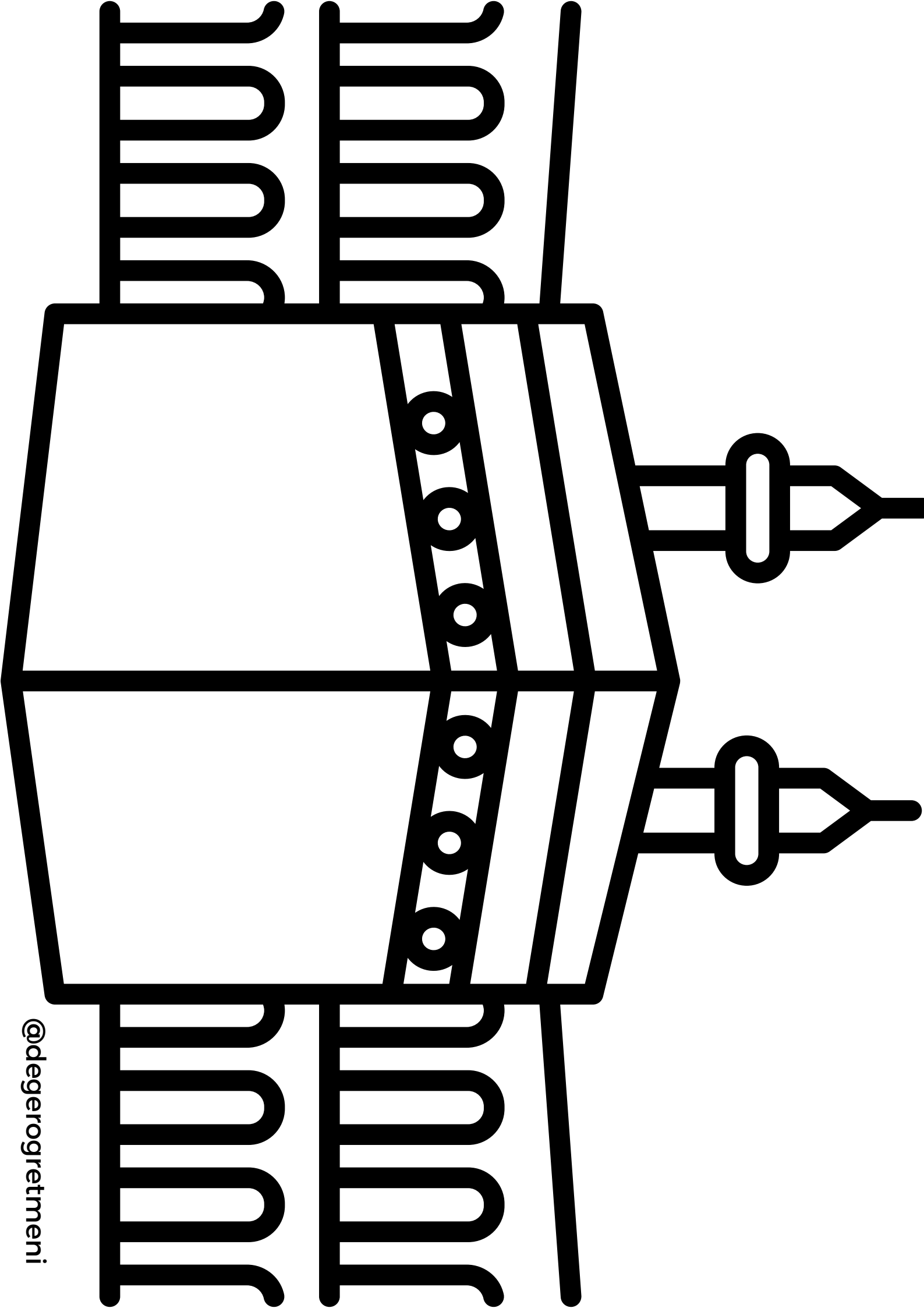



# Kabe nerede?

## Ben neredeyim?

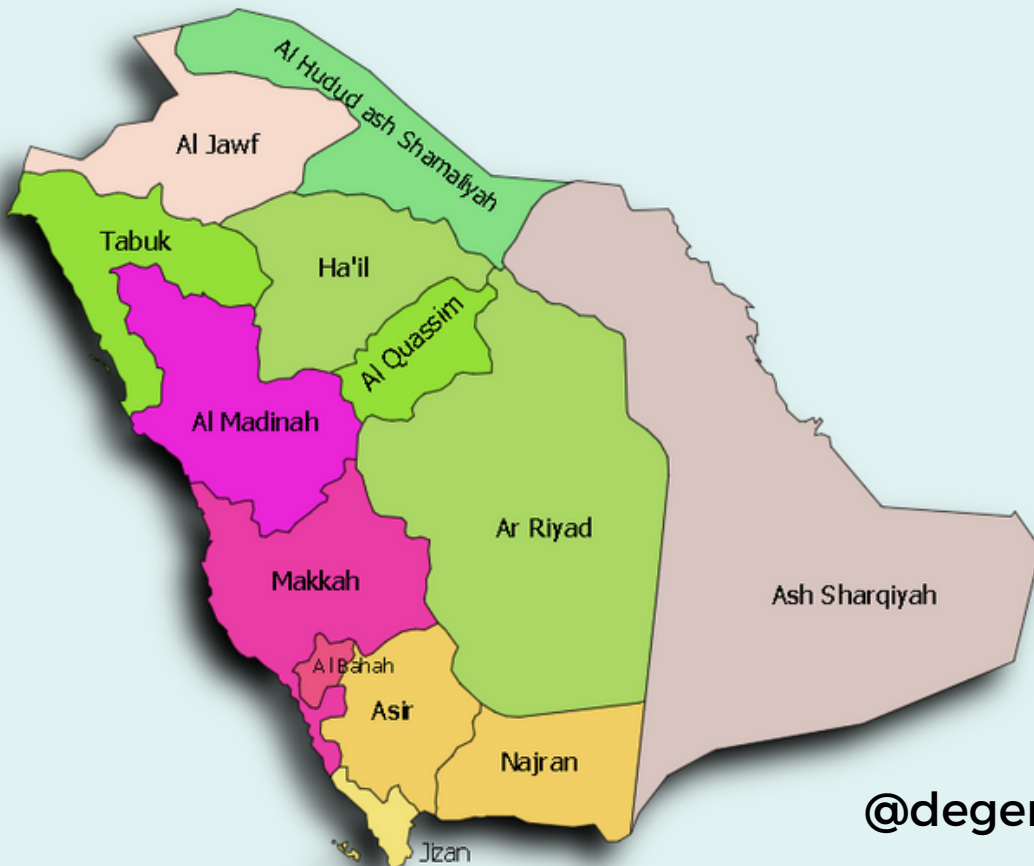

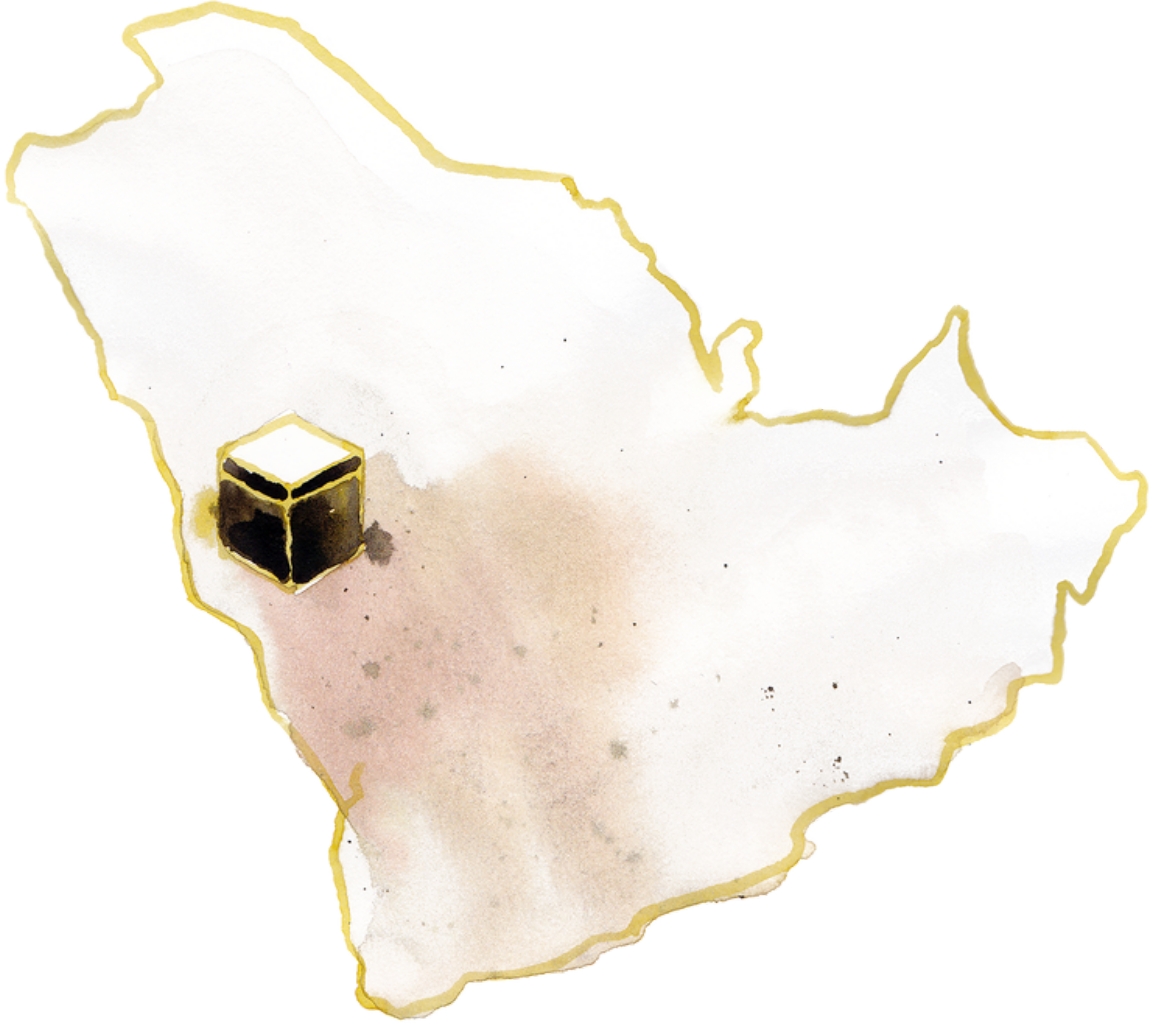

**Mekke'ye gideceđin uađı  
istediđin renkte boya**

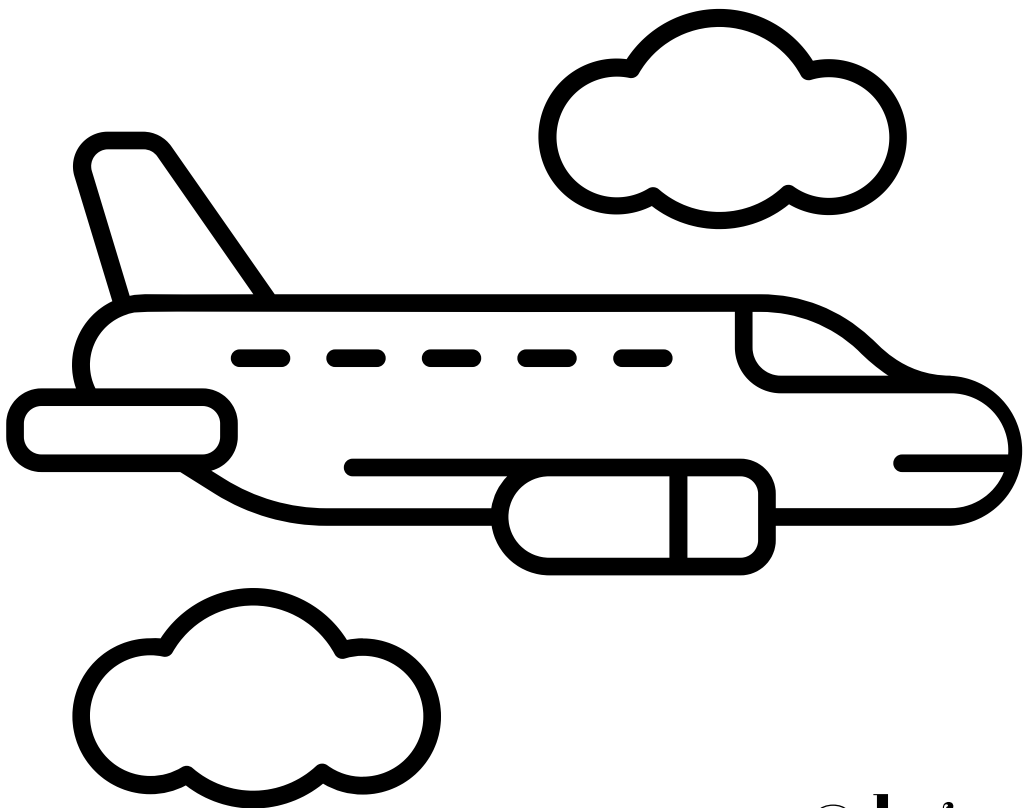

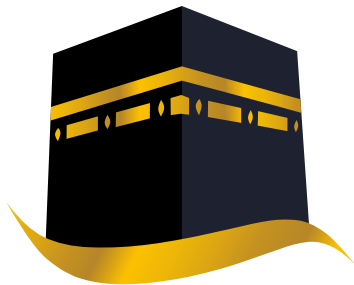
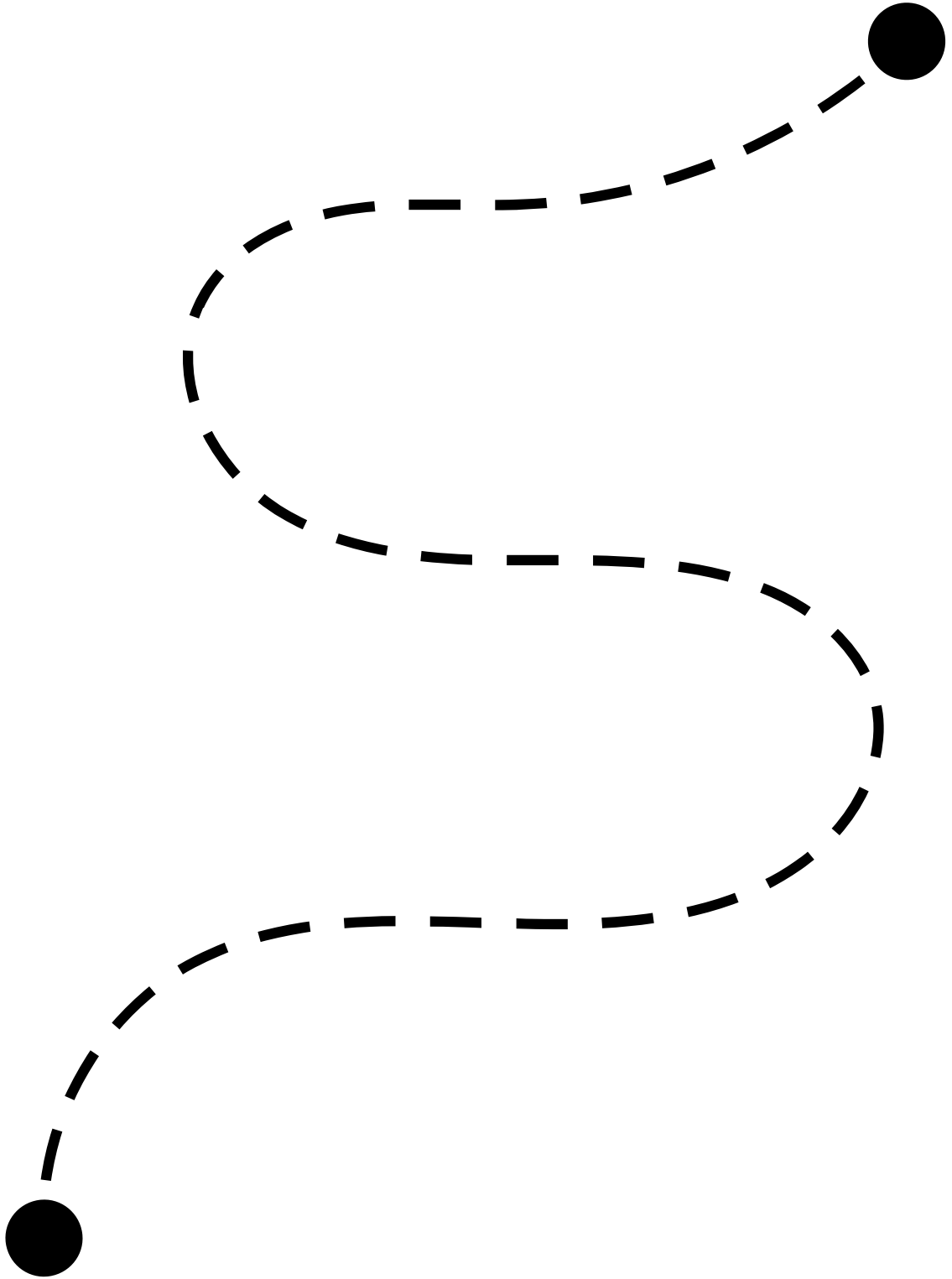

# Peygamberimiz Medine'den Mekke'ye devesiyle yolculuk yapmıştır

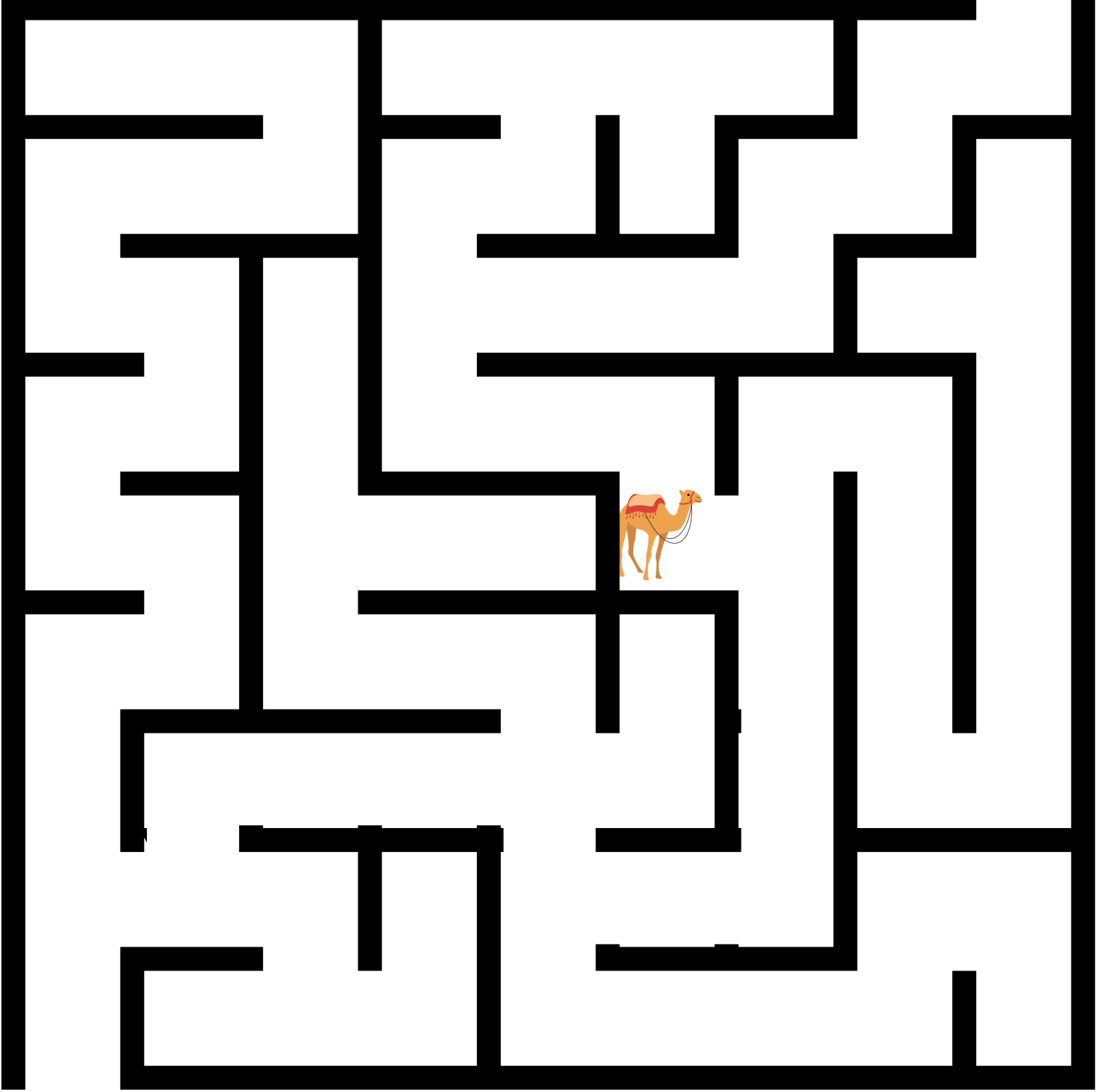

**Mekke'nin fethiyle Kabe ve çevresindeki  
insanlar huzura ve mutluluđa kavuřtu**

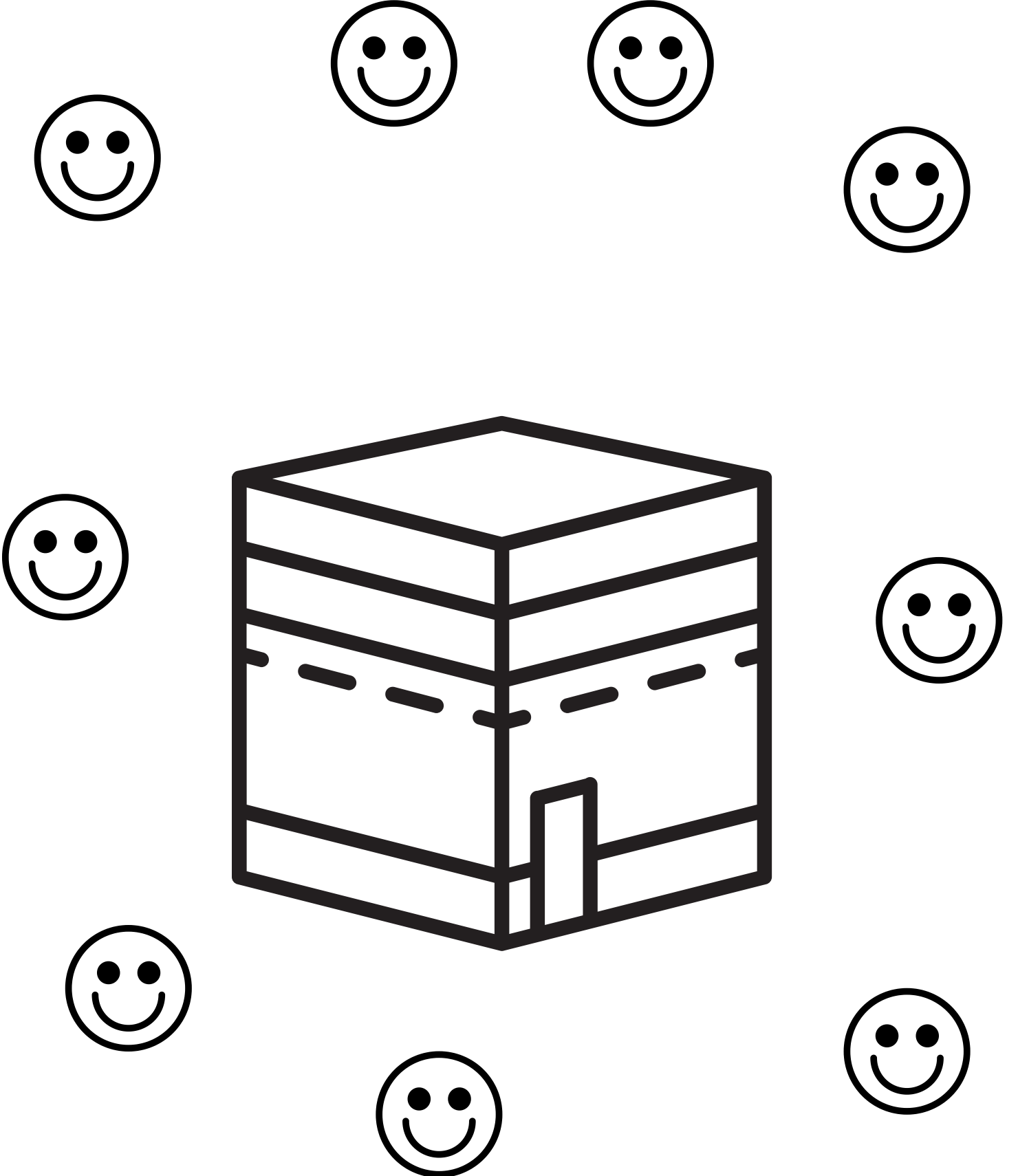

# Mekke'nin fethiyle Kabe'de ilk ezan Hz Bilal tarafından okundu ve Peygamberimiz namaz kıldırdı

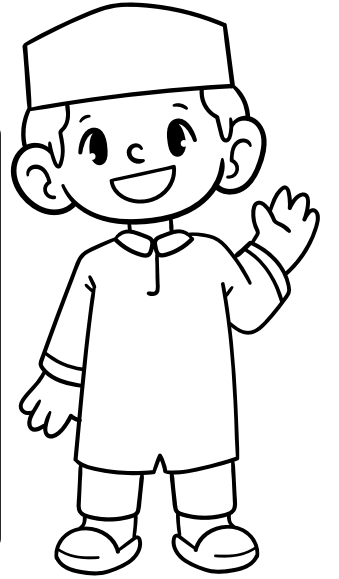
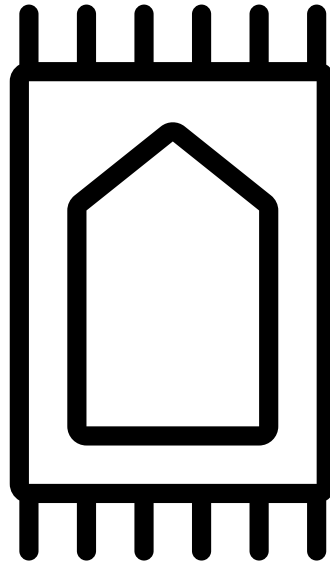
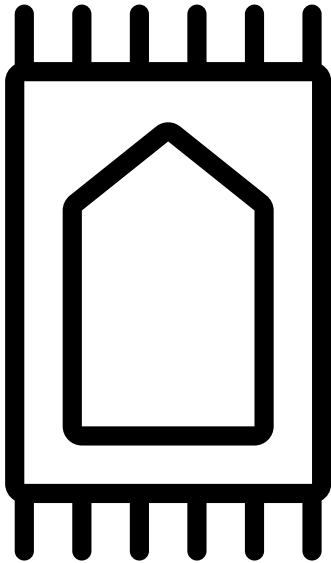
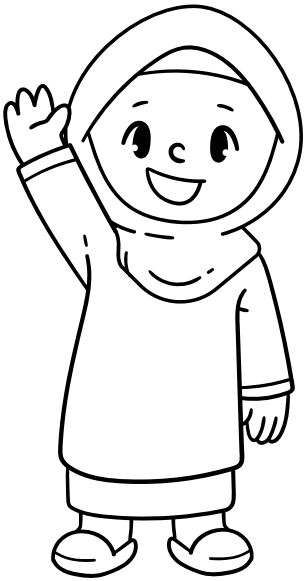
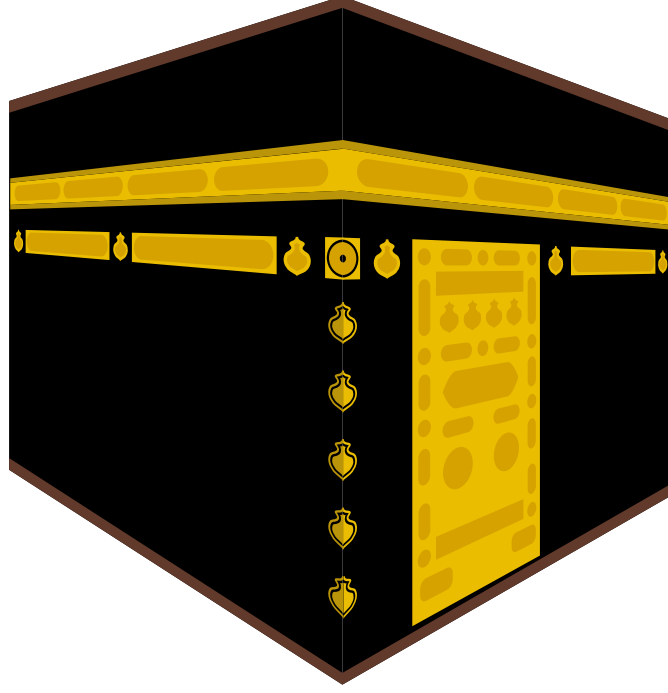



# Tesbih tanelerini “Allahu Ekber” diyerek boya

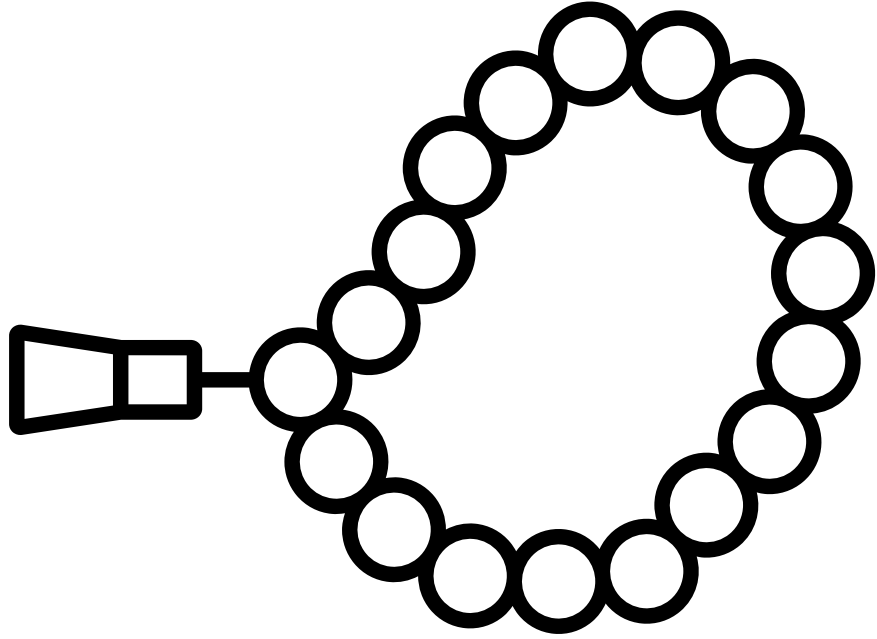

**Elin içine duanı çiz**

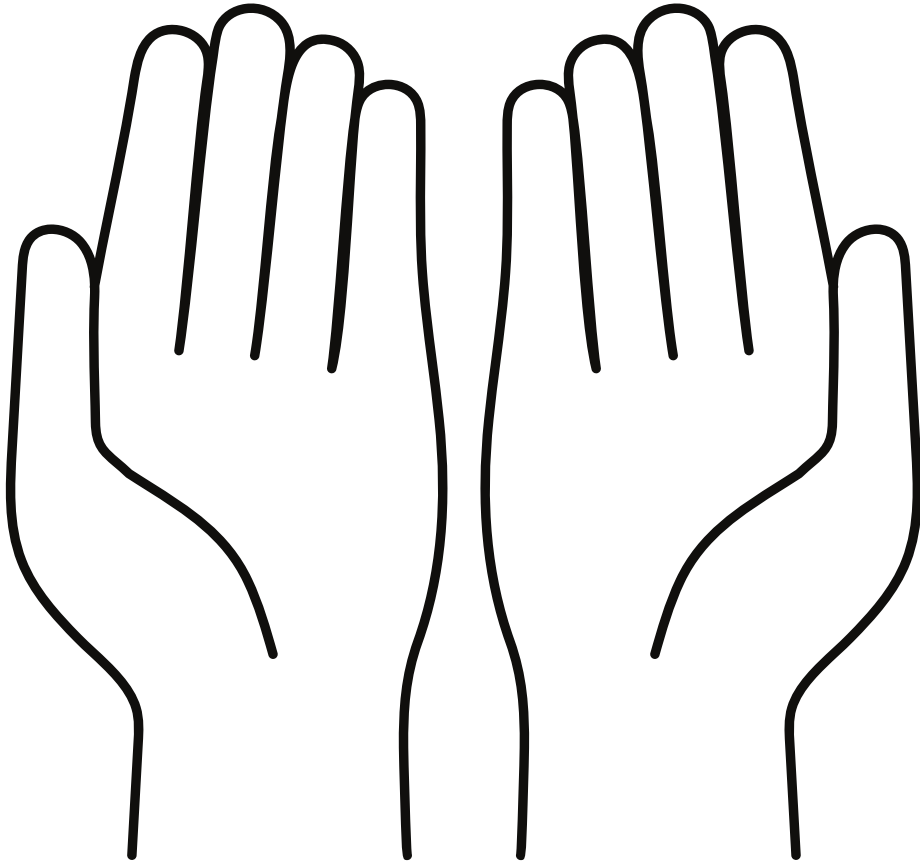

**K  
A  
B  
B  
E**

**M  
A  
K  
E  
T  
i**

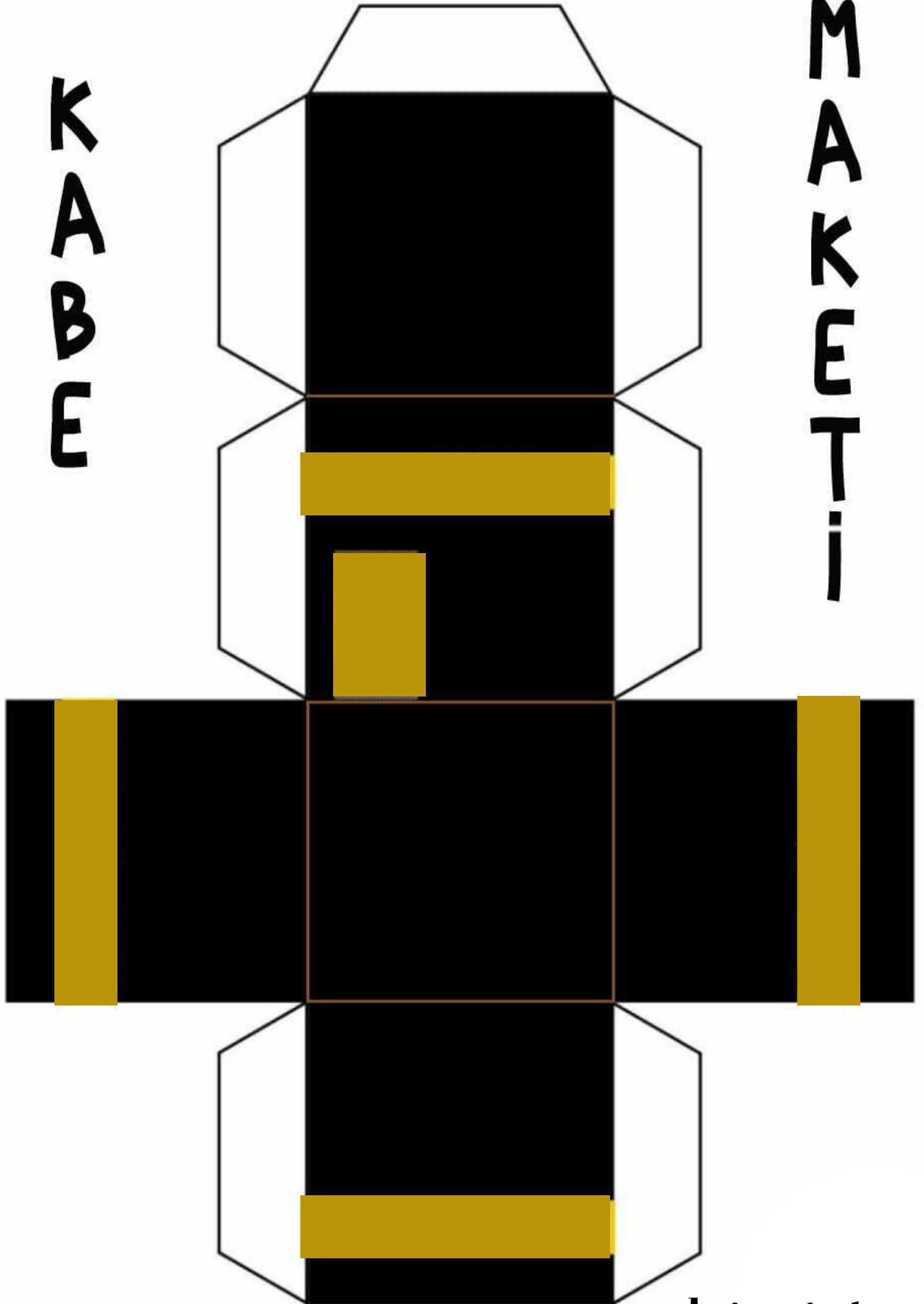

**Dünyanın her yerinden  
müslümanlar sevgiyle,  
mutlulukla kiblemiz  
Kabe'ye yönelir**



# Ne zaman Kabe'ye dönerim?



Kuran  
Okurken



Namaz  
kılarken

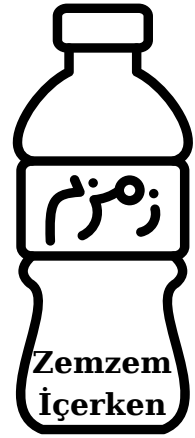

Zemzem  
İçerken



Dua  
ederken

**Kabe'yi ziyaret eden mslmanlar  
Kabe'nin etrafında yedi defa  
dnerler, buna tavaf denilir.**

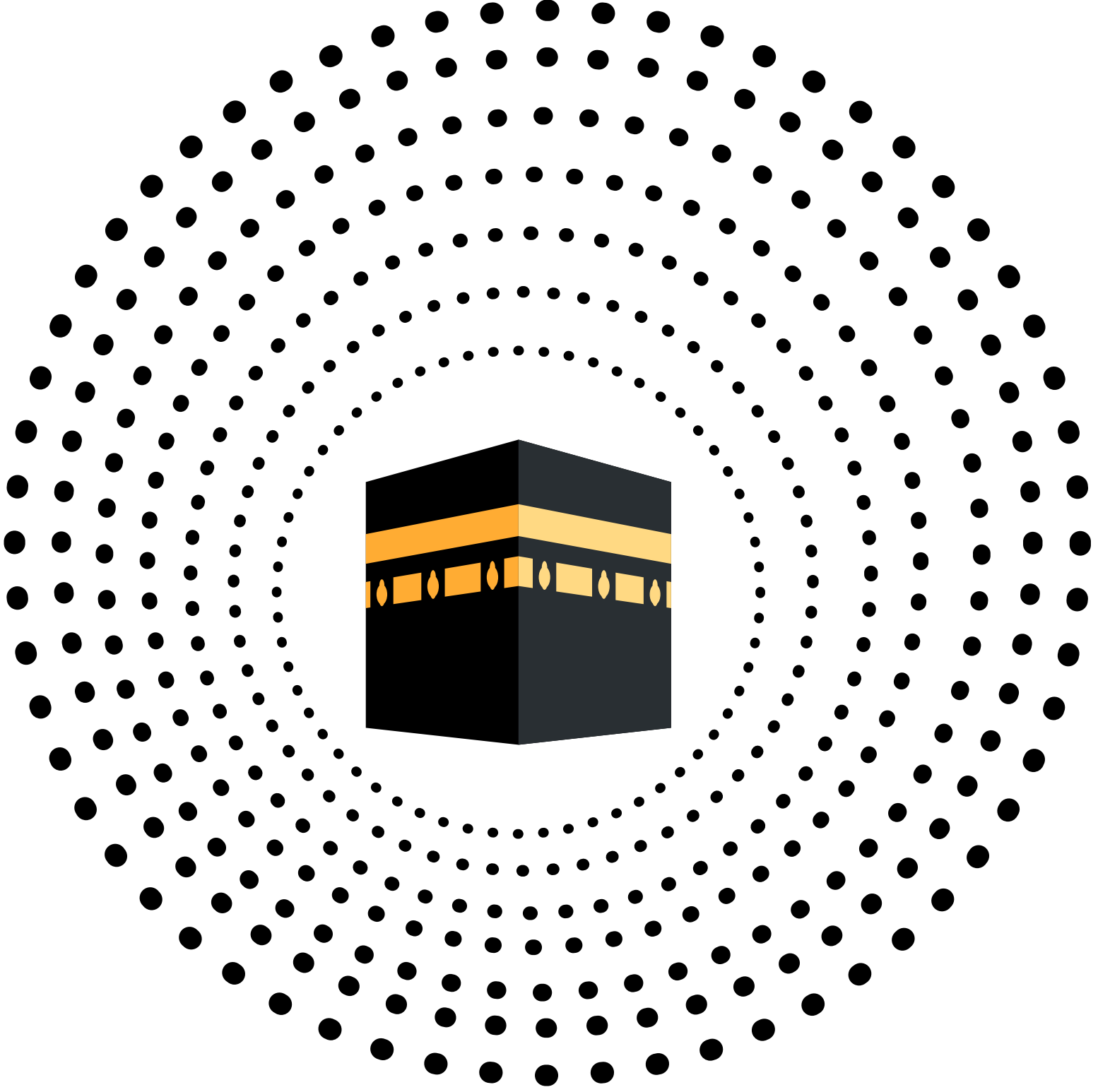

**Bu bölgenin tamamına  
Mescidi Haram denilir**

